

Reduces

- Damage to goods
- Damage to forklift
- Fuel consumption
- Damage to loading deck

Increases

- Safety
- Driving time efficiency

Misc.

- Helper is not required

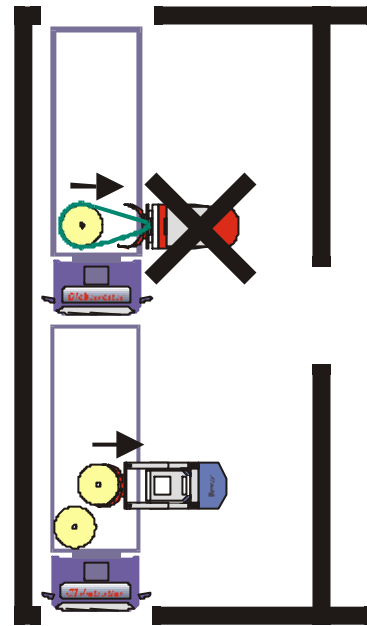
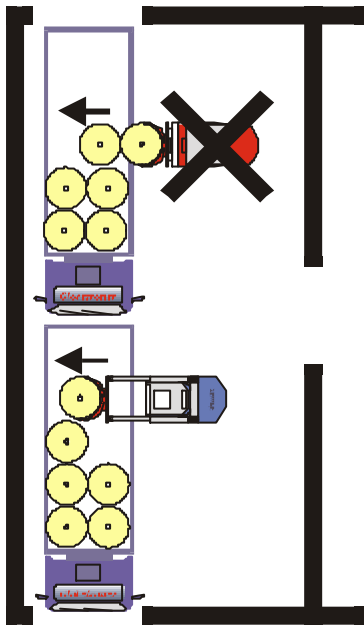

Reduces

- Space requirement for loading / unloading
- Fuel consumption
- Handling time for forklift
- Crash risk

Increases

- Safety for drivers and other personnel in the warehouse

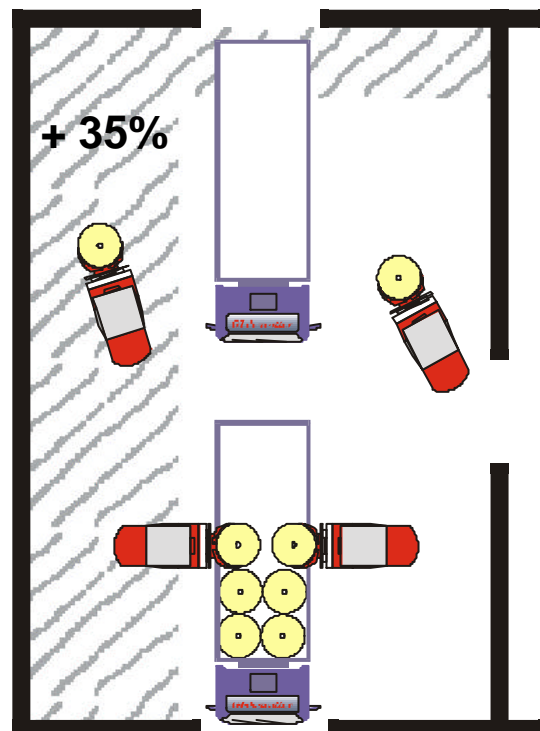
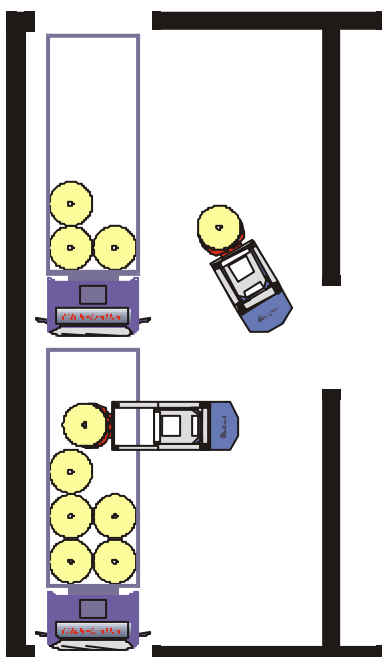

Reduces

- Damage to goods
- Damage to forklift
- Damage to lorry
- Handling time

Increases

- Safety
- Accessibility
- Flexibility
- Utilization of loading area

Misc.

- Full reach with "short" forks and without additional equipment

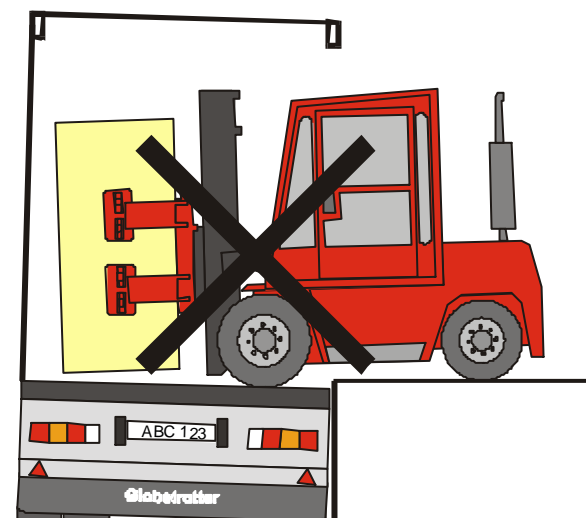
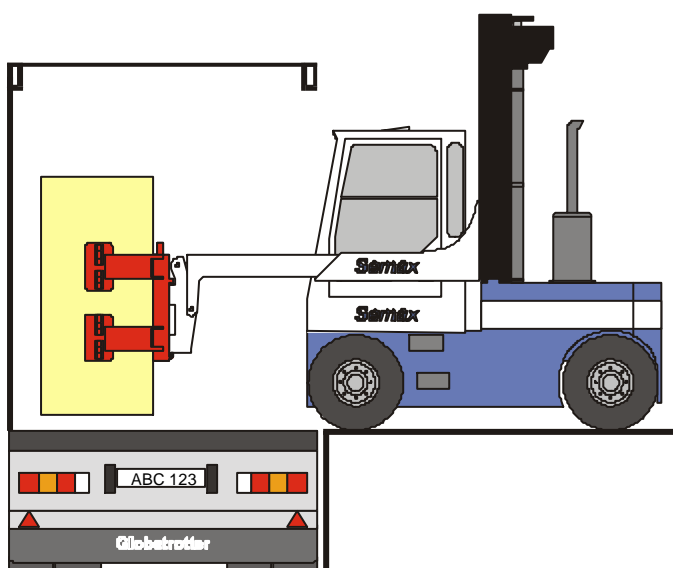
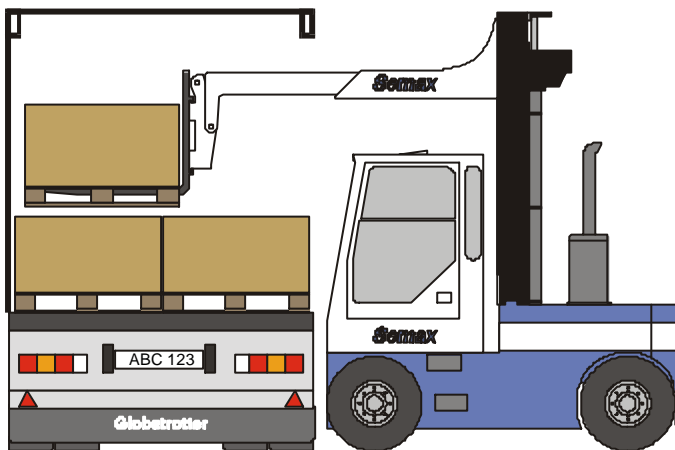

Controls

- Lifting capacity / Load
- Extension / Load
- Driving speed / Extension / Load
- Driving speed / Lifting height

If needed

- Cuts off lifting
- Cuts off extension
- Decreases driving speed
- - " -

